

































Bagsværd Kirke

Tovvej
S. N. O. H.





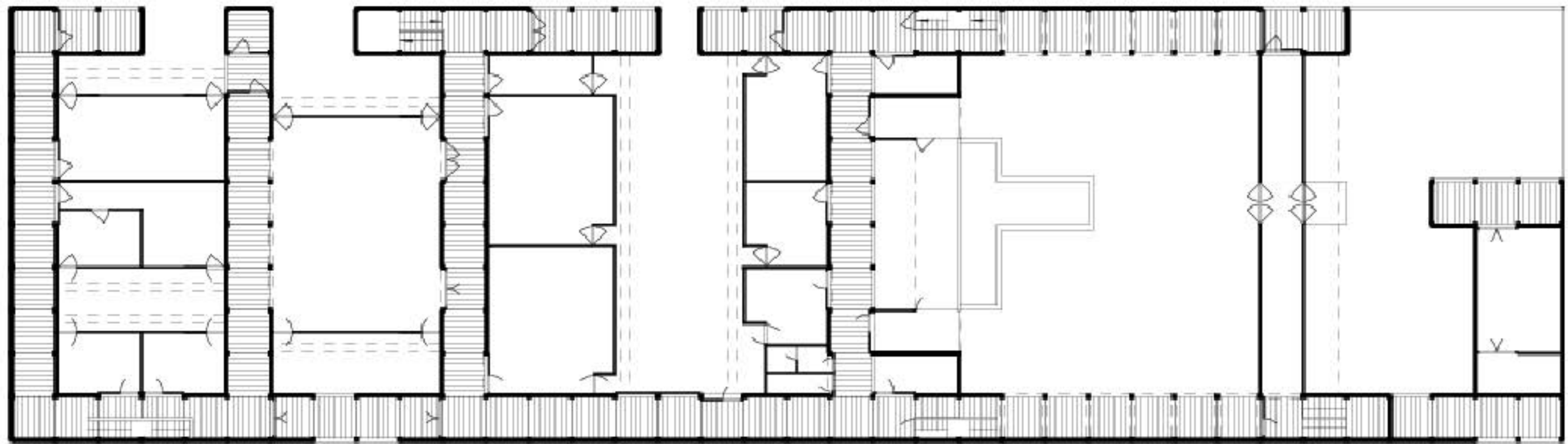
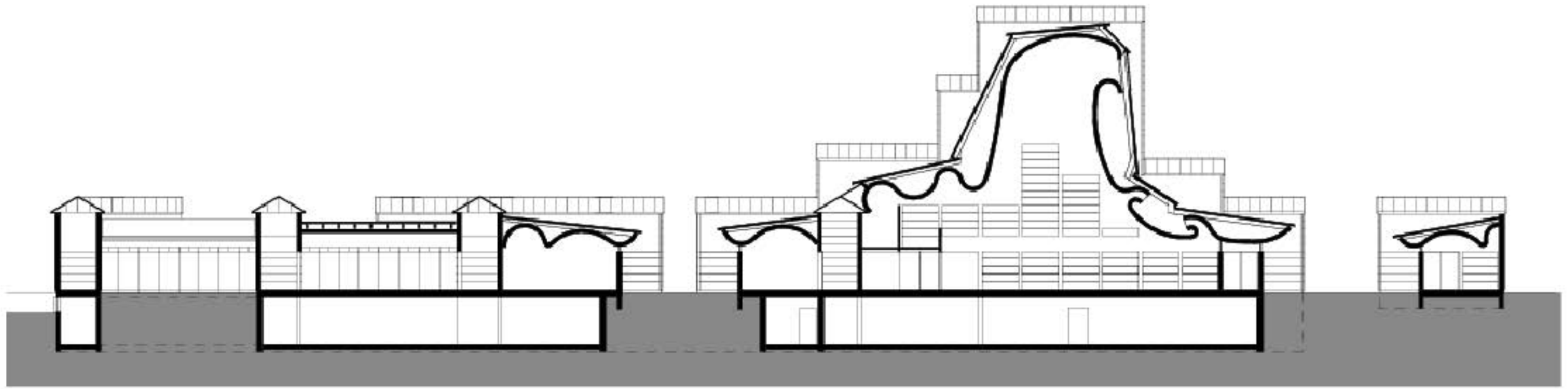





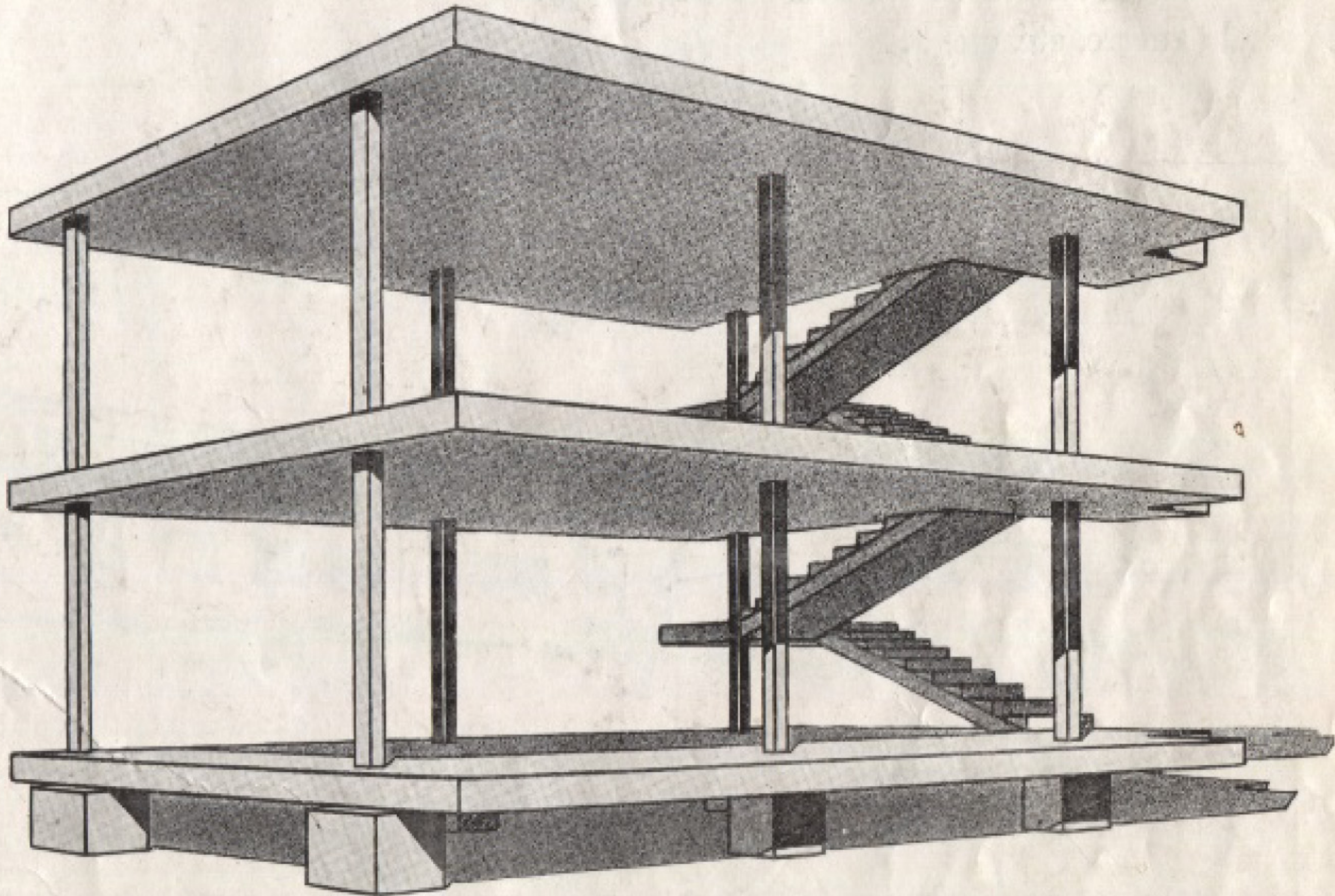

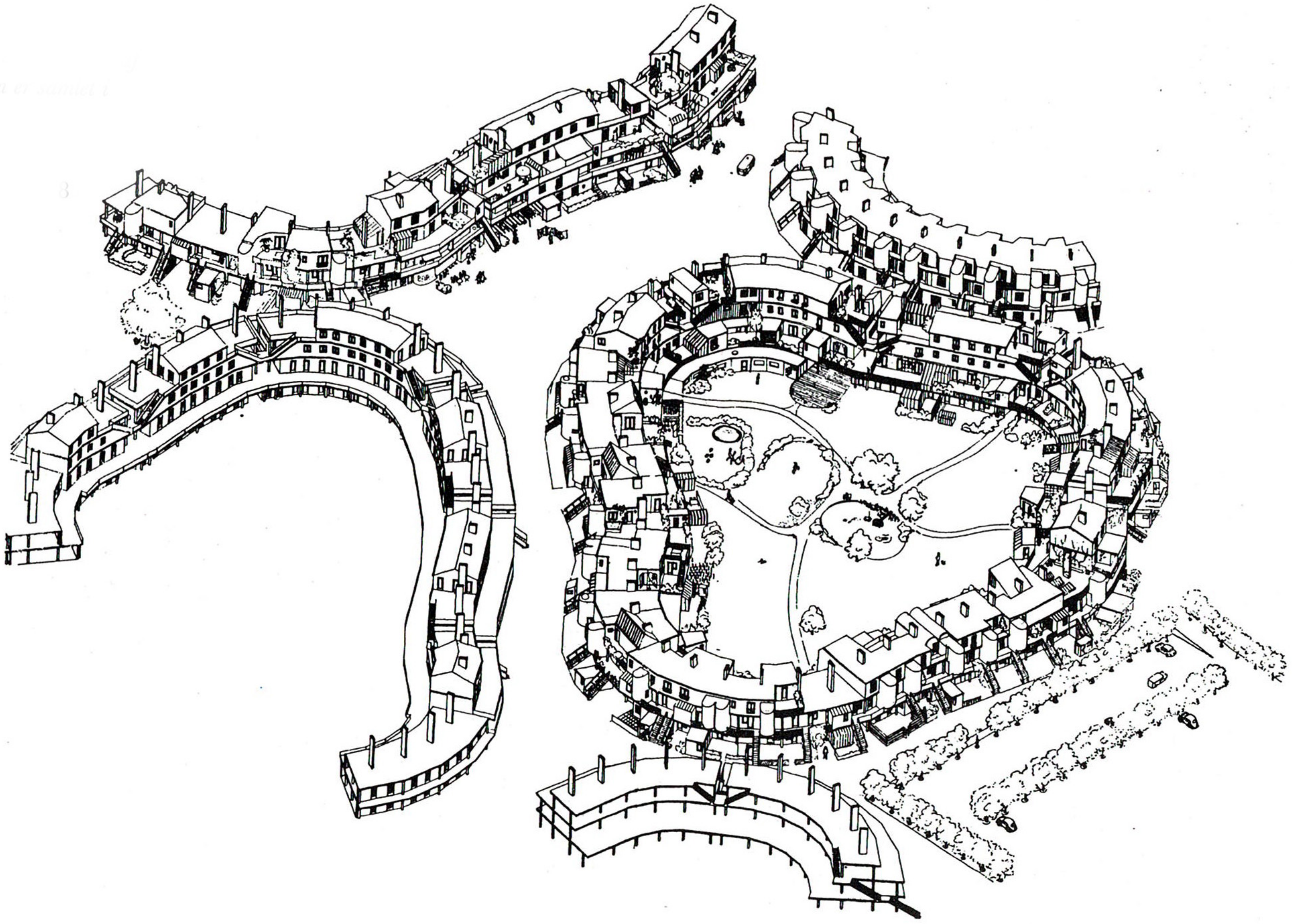





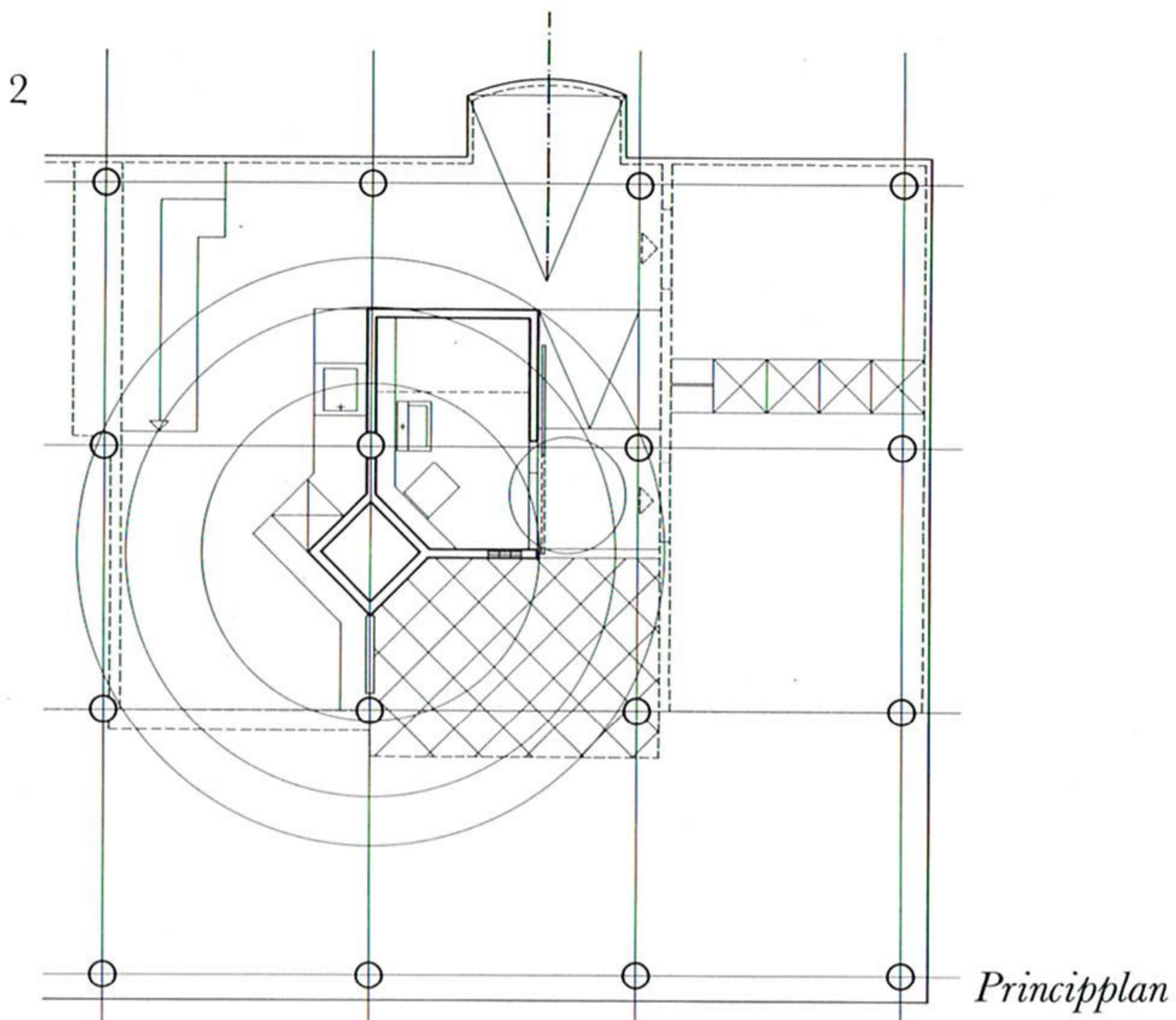

1-4. Arkitektgruppen i Aarhus: Det nye etagehus. Isometri fra førstepræmie i konkurrence 1983. Eksempel på byggesystemets anvendelse, Damhusengen, Rødovre. 1990. Foto: Arkitekterne.

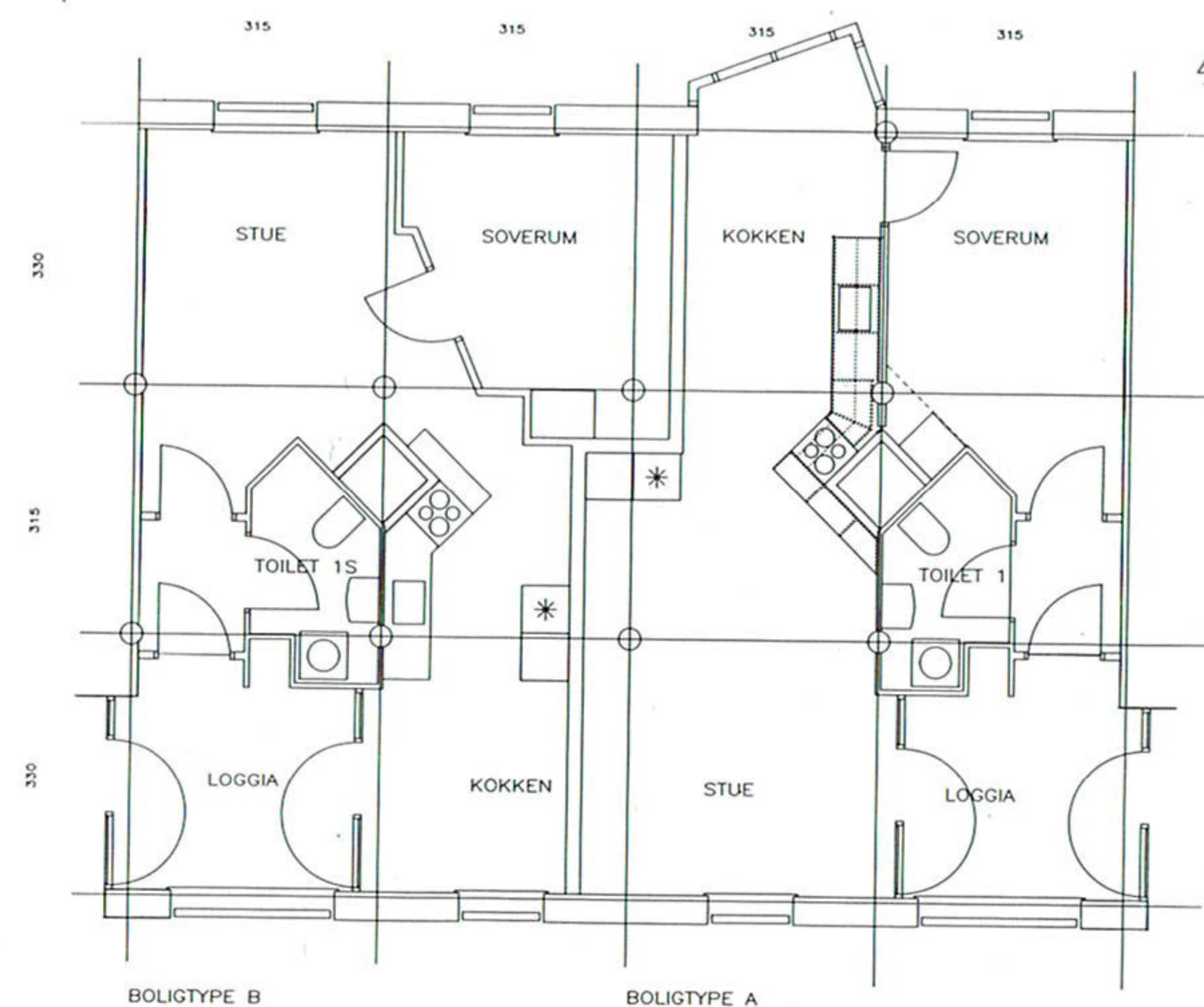
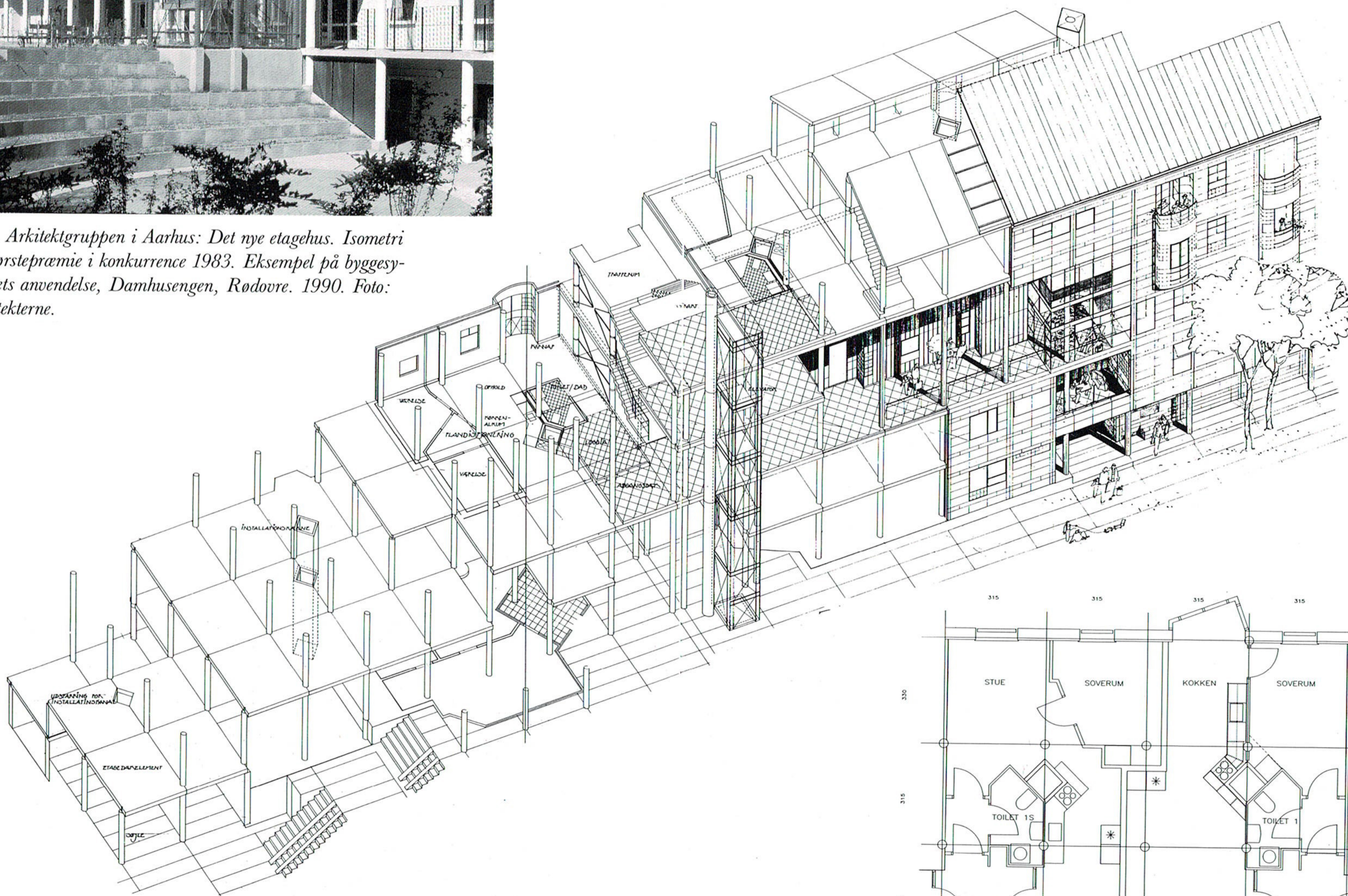

Eksempel på lejlighedsplaner.



199 ↑ 201
→





















HOTEL
RESTAURANT



